

General Information

The FT415 is a microcontroller-based rate/total indicator powered by a lithium battery. It displays rate and total, and provides a programmable pulse output for use in metering pump pacing or datalogging.

The rugged cast-aluminum housing is gasketed for maximum environmental protection, and the electronics are potted into a solid block of urethane. A membrane keypad allows settings to be changed without removing the cover. The wall mount version comes with brackets for wall mounting, and a kit (MK10) is available for field installation on TX80-series flow sensors. The FT415 can also be factory or field installed on a TX100/200 series sensor or WT meter. (Micropower sensors are required to prolong battery life.)

The standard output is a programmable 0.1 second open-collector transistor (TTL) pulse which can be used to trigger most externally-paced metering pumps.

Specifications

Display	
Rate	6-digit autorange, 1/2" character height
Total	8-digit, 5/16" character height
Pulse Output	0.1 second open collector pulse
Input	Micro-power GMR sensor (square wave)
Input Range	Minimum: 20 mV peak-peak Maximum: 6V peak-peak
K factor Range	0.050 - 999999.9
Pulse Output Range	0.1 - 200,000 units/pulse
Battery Type	Lithium "C", 3V, replaceable
Normal Battery Life	3-5 years
Temperature	0 C - 70 C
Environmental	NEMA 4X

Features

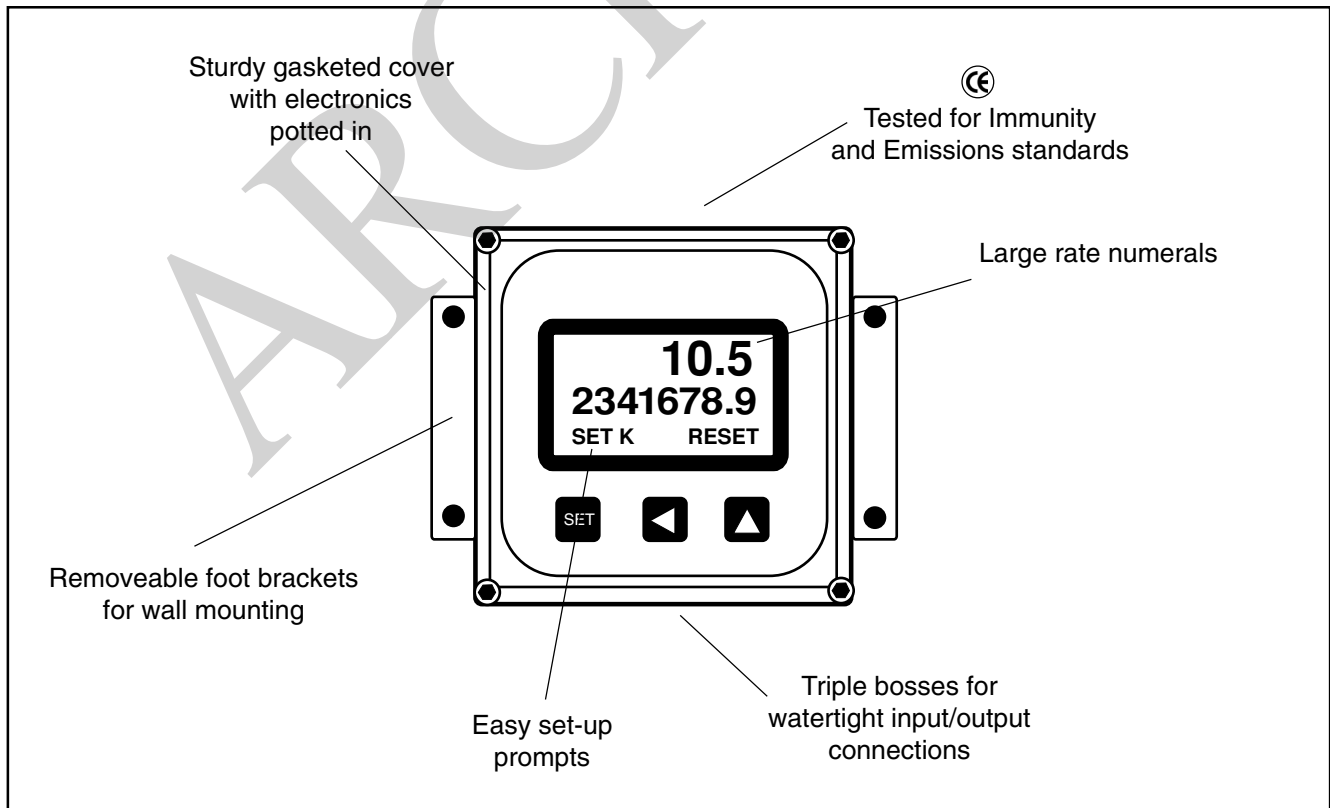

Installation

To mount the FT415W on a wall, hold the unit in the desired position, mark the holes in the mounting feet, drill, and mount with screws.

This unit can also be mounted directly on a flow sensor for local reading. Note that the FT415 requires the optional micropower sensor, in order to conserve battery life. For loop or other external power, the FT420 is recommended, and can be installed on any standard sensor.

If the unit was ordered as an FT415M, factory mounted to the top of a 100 or 200 Series flow sensor, no further installation is required.

To mount the unit on a flow sensor, an MK10 mounting kit is required. Then remove the housing cover. Place the lower half of the housing in the groove on the top of the flow sensor. An adapter from the kit is included in the lower housing, which threads into the top of any 80-Series flow sensor. Pull the sensor wires through the hole in the center of this adapter, then thread the adapter into place. Tighten the adapter using a screwdriver. (See diagram). Connect the wires, then replace the housing cover, orienting it any direction as desired for viewing convenience.

Connection

To connect to the FT415 to a flow sensor, follow the diagram marked "Connections". This diagram also shows the connections for an external device, such as a chemical metering pump.

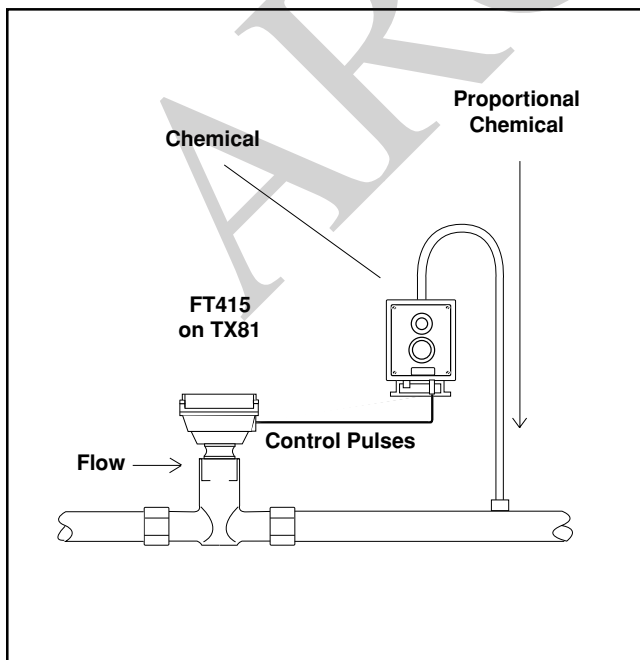

Programming



Caution: If pulse output is being used to control an external device, such as a metering pump, do not connect the pulsed device until programming is completed. If malfunction or incorrect programming of the pulse output could cause personal injury or property damage, separate safeguards must be installed to prevent such injury or damage.



At a minimum, every FT415 must be programmed with the "K-factor". This is simply the number of pulses per gallon which the meter or flow sensor produces. (If you wish the FT415 to read in another unit, enter the number of pulses per that unit. For example, if the desired units are liters, the K-factor is the number of pulses per liter that the flow sensor produces.)

To find the K-factor on any SeaMetrics flow sensor fitting or in-line meter, look on the model-serial label. The line reading $K = \text{xxxx}$ is the desired number. For adjustable sensors (101,201,115,215) look in the instruction manual under your pipe size.

Set K. Begin by pressing the key SET once. The prompt SET K should appear on the display. The digit to the far right will be blinking. Use the up arrow key to reach your desired digit. Then press the left arrow key to move to the next digit. Repeat the process until the entire number is entered. (Note that the decimal is fixed at three places. If you only have two decimal places for your K-factor, enter a zero for the third digit.)

Set P. If the pulse output is to be used, set the desired pulse rate. **Note: If the pulse output feature is not being used, this step can be skipped. The P (pulse output) setting does not affect anything if it is not being used.** This is the number of gallons (or other units, if you are using them) between pulses. The second time the SET key is pressed, SET P will appear. Follow the same process as above to enter the desired number.

Pressing all three buttons at once will put the unit into low alarm. Pressing all three again will put the unit into high alarm.

Press the ARROW LEFT  and ARROW UP  keys to set the flow rate at which you want to have the output pulse switch on.

Sensor Mount: Step 1

Sensor Wires

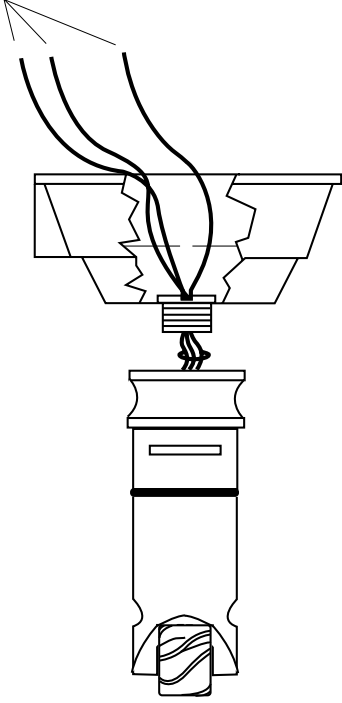

Sensor Mount: Step 2

Sensor Wires

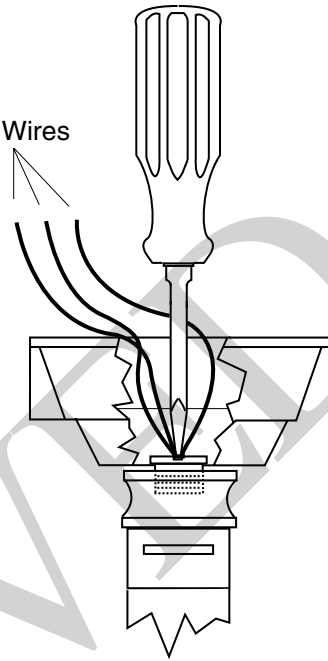

Standard Connections

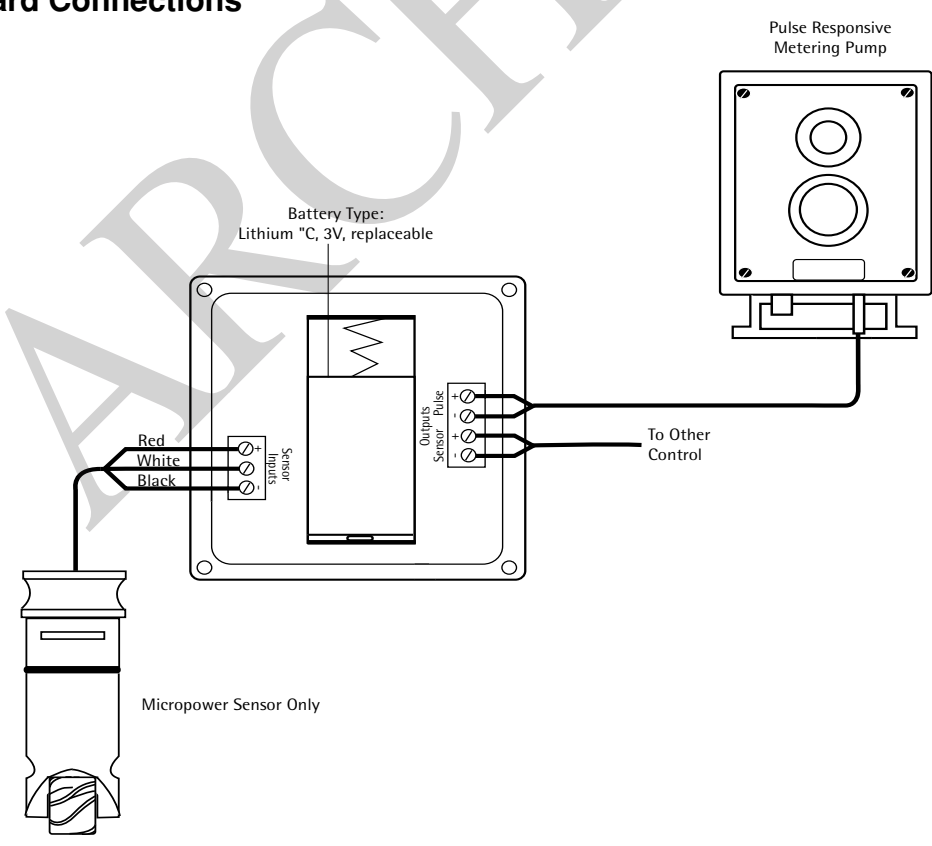

Set Decimal Point. The third time the SET key is pressed, a D prompt appears. Pressing the up arrow key switches back and forth between no decimal place and one decimal place.

Set Time Unit. The fourth time the SET key is pressed, a blinking arrow appears. Press the up arrow key to select S (seconds), M (minutes), H (hours) or D (days).

Operation

To return to normal operation after entering settings, press SET for a fourth time. The rate and total indicator numbers should appear in the display. If the unit is connected to an operating flow sensor, the larger-sized digits indicate flow rate and the smaller-sized digits indicate total.

Unless the unit has been ordered with the non-reset option, a RESET prompt is constantly visible in the lower right corner, above the up arrow key. Press this key at any time to reset the totalizer to zero.

Battery Change

The expected average life of the battery is approximately four years, with a range of 3-5 depending on the frequency of the input. Pull the battery from its holder and replace it with the new one. Note that when the battery is removed, all of the settings previously entered will be retained. However, the totalizer will reset to a previous total, which represents the last auto-backup (approximately one hour intervals.) If it is necessary to save the exact current total at the time of the battery change, save before removing the battery, by simultaneously pressing the SET and up arrow keys. Then press SET again, then again simultaneously press the SET and up arrow keys.

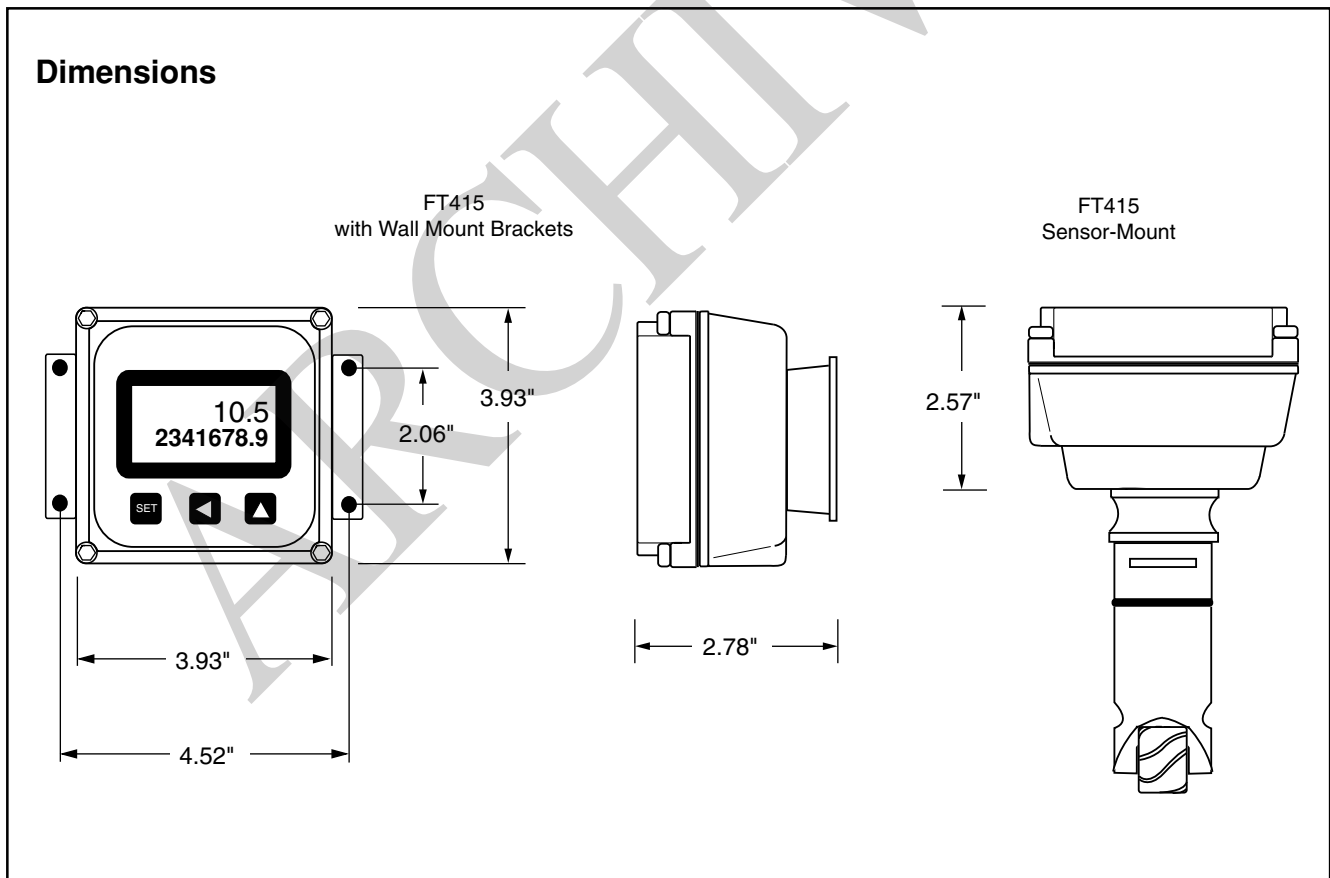

SeaMetrics

20419 80th Ave. So., Kent WA. 98032 USA
Phone: 253-872-0284 Fax: 253-872-0285
www.seametrics.com 1-800-975-8153